

Marking Scheme
Strictly Confidential
(For Internal and Restricted use only)
Senior School Certificate Examination, 2024
SUBJECT NAME PHYSICS (Theory) (CODE 55/1/1)

General Instructions: -

1	You are aware that evaluation is the most important process in the actual and correct assessment of the candidates. A small mistake in evaluation may lead to serious problems which may affect the future of the candidates, education system and teaching profession. To avoid mistakes, it is requested that before starting evaluation, you must read and understand the spot evaluation guidelines carefully.
2	“Evaluation policy is a confidential policy as it is related to the confidentiality of the examinations conducted, Evaluation done and several other aspects. Its’ leakage to public in any manner could lead to derailment of the examination system and affect the life and future of millions of candidates. Sharing this policy/document to anyone, publishing in any magazine and printing in News Paper/Website etc may invite action under various rules of the Board and IPC.”
3	Evaluation is to be done as per instructions provided in the Marking Scheme. It should not be done according to one’s own interpretation or any other consideration. Marking Scheme should be strictly adhered to and religiously followed. However, while evaluating, answers which are based on latest information or knowledge and/or are innovative, they may be assessed for their correctness otherwise and due marks be awarded to them. In class-X, while evaluating two competency-based questions, please try to understand given answer and even if reply is not from marking scheme but correct competency is enumerated by the candidate, due marks should be awarded.
4	The Marking scheme carries only suggested value points for the answers These are in the nature of Guidelines only and do not constitute the complete answer. The students can have their own expression and if the expression is correct, the due marks should be awarded accordingly.
5	The Head-Examiner must go through the first five answer books evaluated by each evaluator on the first day, to ensure that evaluation has been carried out as per the instructions given in the Marking Scheme. If there is any variation, the same should be zero after deliberation and discussion. The remaining answer books meant for evaluation shall be given only after ensuring that there is no significant variation in the marking of individual evaluators.
6	Evaluators will mark(√) wherever answer is correct. For wrong answer CROSS ‘X’ be marked. Evaluators will not put right (✓) while evaluating which gives an impression that answer is correct and no marks are awarded. This is most common mistake which evaluators are committing.
7	If a question has parts, please award marks on the right-hand side for each part. Marks awarded for different parts of the question should then be totaled up and written in the left-hand margin and encircled. This may be followed strictly.

8	If a question does not have any parts, marks must be awarded in the left-hand margin and encircled. This may also be followed strictly.
9	If a student has attempted an extra question, answer of the question deserving more marks should be retained and the other answer scored out with a note “ Extra Question ”.
10	No marks to be deducted for the cumulative effect of an error. It should be penalized only once.
11	A full scale of marks 0 to 70 has to be used. Please do not hesitate to award full marks if the answer deserves it.
12	Every examiner has to necessarily do evaluation work for full working hours i.e., 8 hours every day and evaluate 20 answer books per day in main subjects and 25 answer books per day in other subjects (Details are given in Spot Guidelines). This is in view of the reduced syllabus and number of questions in question paper.
13	<p>Ensure that you do not make the following common types of errors committed by the Examiner in the past:-</p> <ul style="list-style-type: none"> ● Leaving answer or part thereof unassessed in an answer book. ● Giving more marks for an answer than assigned to it. ● Wrong totaling of marks awarded on an answer. ● Wrong transfer of marks from the inside pages of the answer book to the title page. ● Wrong question wise totaling on the title page. ● Wrong totaling of marks of the two columns on the title page. ● Wrong grand total. ● Marks in words and figures not tallying/not same. ● Wrong transfer of marks from the answer book to online award list. ● Answers marked as correct, but marks not awarded. (Ensure that the right tick mark is correctly and clearly indicated. It should merely be a line. Same is with the X for incorrect answer.) ● Half or a part of answer marked correct and the rest as wrong, but no marks awarded.
14	While evaluating the answer books if the answer is found to be totally incorrect, it should be marked as cross (X) and awarded zero (0) Marks.
15	Any un assessed portion, non-carrying over of marks to the title page, or totaling error detected by the candidate shall damage the prestige of all the personnel engaged in the evaluation work as also of the Board. Hence, in order to uphold the prestige of all concerned, it is again reiterated that the instructions be followed meticulously and judiciously.
16	The Examiners should acquaint themselves with the guidelines given in the “ Guidelines for spot Evaluation ” before starting the actual evaluation.
17	Every Examiner shall also ensure that all the answers are evaluated, marks carried over to the title page, correctly totaled and written in figures and words.
18	The candidates are entitled to obtain photocopy of the Answer Book on request on payment of the prescribed processing fee. All Examiners/Additional Head Examiners/Head Examiners are once again reminded that they must ensure that evaluation is carried out strictly as per value points for each answer as given in the Marking Scheme.

MARKING SCHEME : PHYSICS (042)

CODE :55/1/1

Q.NO.	VALUE POINT/EXPECTED ANSWERS	MARKS	TOTAL MARKS		
	<u>Section A</u>				
1.	(B) Zero	1	1		
2.	(D) $5.0 \times 10^{-2} \text{ J}$	1	1		
3.	(B) 8V	1	1		
4.	(C) Shrink	1	1		
5.	(B) $(-0.8 \text{ mN}) \hat{i}$	1	1		
6.	(B) $\frac{G}{1000} \Omega$	1	1		
7.	(A) $\frac{X}{6}$	1	1		
8.	(A) I	1	1		
9.	(C) $n_f = 2$ and $n_i = 4$	1	1		
10.	(B) the number of conduction electrons increases	1	1		
11.	(C) $\frac{1}{3}$	1	1		
12.	(A) momentum	1	1		
13.	(D) Assertion (A) is false and reason (R) is also false.	1	1		
14.	(A) Both Assertion (A) and Reason (R) are true and Reason (R) is the correct explanation of the Assertion (A)	1	1		
15.	(A) Both Assertion (A) and Reason (R) are true and Reason (R) is the correct explanation of the Assertion (A)	1	1		
16.	(D) Assertion (A) is false and reason (R) is also false.	1	1		
	<u>Section B</u>				
17.	<table border="1" style="width: 100%; border-collapse: collapse;"> <tr> <td style="padding: 5px;">Finding the temperature</td> <td align="right" style="padding: 5px;">2</td> </tr> </table> <p> $R = R_0 [1 + \alpha (T - T_0)]$ $R = 2R_0$ [Given] $2R_0 = R_0 [1 + \alpha (T - T_0)]$ On solving $T = T_0 + 250$ $T = 270^\circ\text{C}$ or 543 K </p>	Finding the temperature	2	<p>$\frac{1}{2}$</p> <p>$\frac{1}{2}$</p> <p>1</p>	2
Finding the temperature	2				

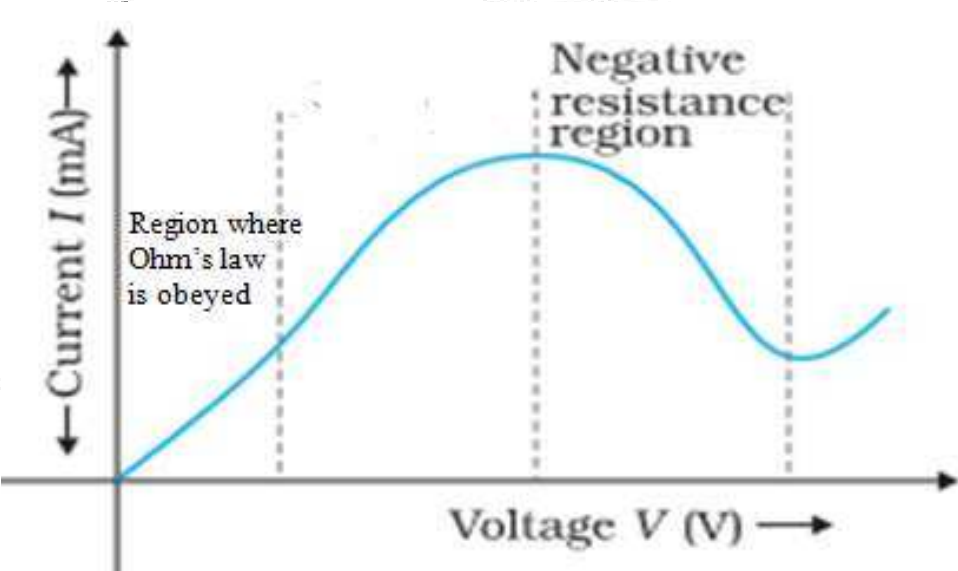
	<p>(ii) $m = -\frac{v}{u}$ $= -\left(\frac{-60}{-30}\right)$ $= -2$</p>	<p>$\frac{1}{2}$ $\frac{1}{2}$</p>	<p>2</p>
<p>20.</p>	<div style="border: 1px solid black; padding: 5px; margin-bottom: 10px;"> <p>Obtaining an expression for λ_n / λ_p 2</p> </div> <p>$E = \frac{hc}{\lambda_p} \Rightarrow \lambda_p = \frac{hc}{E}$</p> <p>$\lambda_n = \frac{h}{p} = \frac{h}{\sqrt{2mE}}$</p> <p>$\frac{\lambda_n}{\lambda_p} = \frac{h}{\sqrt{2mE}} \times \frac{E}{hc}$</p> <p>$\frac{\lambda_n}{\lambda_p} = \sqrt{\left(\frac{E}{2mc^2}\right)}$</p>	<p>$\frac{1}{2}$ $\frac{1}{2}$ $\frac{1}{2}$ $\frac{1}{2}$</p>	<p>2</p>
<p>21.</p>	<div style="border: 1px solid black; padding: 5px; margin-bottom: 10px;"> <p>Plotting the graph 1</p> <p>Marking the region where:</p> <p>(a) resistance is negative $\frac{1}{2}$</p> <p>(b) Ohm's law is obeyed $\frac{1}{2}$</p> </div> 	<p>$1 + \frac{1}{2} + \frac{1}{2}$</p>	<p>2</p>

SECTION C

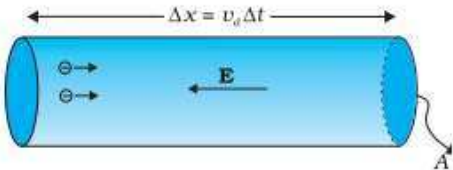
<p>22.</p>	<div style="border: 1px solid black; padding: 5px; margin-bottom: 10px;"> <p>Calculating</p> <p>(a) the flux passing through the cube 2</p> <p>(b) the charge within the cube 1</p> </div> <p>a) $\Phi_L = \vec{E}_L \cdot \vec{A} = - [500 \times 0.1] \times [(0.1)^2] = - 0.5 \text{ N m}^2 \text{ C}^{-1}$</p> <p>$\Phi_R = \vec{E}_R \cdot \vec{A} = [500 \times 0.2] \times [(0.1)^2] = 1 \text{ N m}^2 \text{ C}^{-1}$</p> <p>Net flux = $\Phi_L + \Phi_R = 0.5 \text{ N m}^2 \text{ C}^{-1}$</p> <p>b) flux, $\phi = \frac{q}{\epsilon_0}$</p> <p>charge, $q = \phi \times \epsilon_0$ $= 0.5 \epsilon_0$ $= 4.4 \times 10^{-12} \text{ C}$</p>	<p>$\frac{1}{2}$</p> <p>$\frac{1}{2}$</p> <p>1</p> <p>$\frac{1}{2}$</p> <p>$\frac{1}{2}$</p>	<p align="center">3</p>
<p>23.</p>	<p>a)</p> <div style="border: 1px solid black; padding: 5px; margin-bottom: 10px;"> <ul style="list-style-type: none"> • Defining current density $\frac{1}{2}$ • Whether scalar or vector $\frac{1}{2}$ • Showing $\vec{j} = \alpha \vec{E}$ 2 </div> <p>Current density is the amount of charge flowing per second per unit area normal to the flow.</p> <p>Alternatively:</p> $j = \frac{I}{A}$ <p>It is a vector quantity.</p> <div style="text-align: center; margin: 10px 0;">  </div> <p>The amount of charge crossing the area A in time Δt is $I \Delta t$, where I is the magnitude of the current. Hence,</p> $I \Delta t = ne A v_d \Delta t$	<p>$\frac{1}{2}$</p> <p>$\frac{1}{2}$</p> <p>$\frac{1}{2}$</p>	

$$I \Delta t = \frac{e^2 A}{m} \tau n \Delta t |E|$$

$$I = |j|A$$

$$|j| = \frac{ne^2}{m} \tau |E|$$

$$\vec{j} = \alpha \vec{E}$$

OR

b)

Defining Wheatstone bridge	1
Obtaining balancing conditions	2

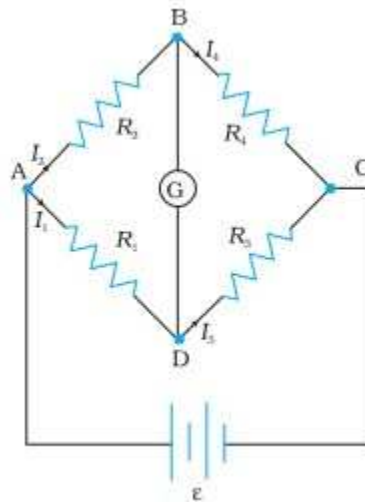

Alternatively:

If the figure is explained in words full credit to be given.

For loop ADDBA:

$$-I_1 R_1 + I_2 R_2 + I_g G = 0 \quad (1)$$

For loop CBDC:

$$I_4 R_4 - I_3 R_3 - I_g G = 0 \quad (2)$$

For balanced wheatstone bridge, $I_g = 0$

And by applying Kirchoff's junction rule to junction D and B,

$$I_1 = I_3 \text{ \& } I_2 = I_4$$

From eqn (1) and (2)

½

½

½

1

½

½

½

	$\frac{I_1}{I_2} = \frac{R_2}{R_1} \quad \text{and} \quad \frac{I_1}{I_2} = \frac{R_4}{R_3}$ $\Rightarrow \frac{R_2}{R_1} = \frac{R_4}{R_3}$	1/2	3
24.	<div style="border: 1px solid black; padding: 5px; margin-bottom: 10px;"> <p>Calculating</p> <p>a) the speed of the proton 1</p> <p>b) the magnitude of the acceleration of the proton 1</p> <p>c) the radius of the path traced by the proton 1</p> </div> <p>a) $v = \sqrt{\left(\frac{2 \times \text{K.E.}}{m}\right)}$</p> <p style="margin-left: 40px;">$= 4 \times 10^6 \text{ m/s}$</p> <p>b) acceleration = qvB / m</p> <p style="margin-left: 40px;">$= 8 \times 10^{11} \text{ m/s}^2$</p> <p>c) $r = mv / Bq$</p> <p style="margin-left: 40px;">$= 20 \text{ m}$</p>	1/2 1/2 1/2 1/2	3
25.	<div style="border: 1px solid black; padding: 5px; margin-bottom: 10px;"> <p>Deriving an expression for the average power dissipated in series LCR circuit 2</p> <p>Obtaining expression for the resonant frequency 1</p> </div> <p>$v = v_m \sin \omega t$</p> <p>$i = i_m \sin(\omega t + \phi)$</p> <p>Power, $P = v i = (v_m \sin \omega t) \times [i_m \sin(\omega t + \phi)]$</p> $= \frac{v_m i_m}{2} [\cos \phi - \cos(2\omega t + \phi)] \quad (1)$ <p>The average power over a cycle is given by the average of the two terms in RHS of eqn (1). It is only the 2nd term which is time dependent. It's average is zero. Therefore,</p> $P = \frac{v_m i_m}{2} \cos \phi$	1/2 1/2 1/2	

	<p> $P = V I \cos \phi$ OR $P = I^2 Z \cos \phi$ </p> <p>At resonance, $X_C = X_L$</p> $\frac{1}{\omega C} = \omega L$ $\omega = \frac{1}{\sqrt{LC}}$ $\Rightarrow \nu = \frac{1}{2\pi\sqrt{LC}}$	<p>1/2</p> <p>1/2</p> <p>1/2</p>	<p>3</p>
<p>26.</p>	<div style="border: 1px solid black; padding: 5px; margin-bottom: 10px;"> <p>a) Two examples 1</p> <p>b) (i) Reason for use of short waves bands 1</p> <p style="padding-left: 20px;">(ii) Reason for x-ray astronomy from satellites 1</p> </div> <p>a) (Any Two)</p> <ul style="list-style-type: none"> • Gamma radiation having wavelength of 10^{-14} m to 10^{-15} m, typically originate from an atomic nucleus. • X-rays are emitted from heavy atoms. • Radio waves are produced by accelerating electrons in a circuit. A transmitting antenna can most efficiently radiate waves having a wavelength of about the same size as the antenna. <p>b) (i) Ionosphere reflects waves in these bands (ii) Atmosphere absorbs x-rays, while visible and radio waves can penetrate it</p> <p>Note: Full credit to be given for part (b) for mere attempt.</p>	<p>1/2 + 1/2</p> <p>1</p> <p>1</p>	<p>3</p>
<p>27.</p>	<div style="border: 1px solid black; padding: 5px; margin-bottom: 10px;"> <ul style="list-style-type: none"> • Drawbacks of Rutherford's atomic model 1 • Bohr's explanation 1 • Showing different orbits are not equally spaced 1 </div> <p>Drawbacks:</p> <p>i) According to classical electromagnetic theory, an accelerating charged particle emits radiation in the form of electromagnetic waves. The energy of an accelerating electron should therefore, continuously decrease. The electron would spiral inward and eventually fall into the nucleus. Thus, such</p>		

	<p>an atom cannot be stable.</p> <p>ii) As the electrons spiral inwards, their angular velocities and hence their frequencies would change continuously. Thus, they would emit a continuous spectrum, in contradiction to the line spectrum actually observed.</p> <p>Bohr postulated stable orbits in which electrons do not radiate energy Alternatively: Bohr's postulates (Any ONE of the three)</p> <p>(i) An electron in an atom could revolve in certain stable orbits without the emission of radiant energy.</p> <p>(ii) The electron revolves around the nucleus only in those orbits for which the angular momentum is some integral multiple of $h/2\pi$</p> <p>(iii) An electron might make a transition from one of its specified non-radiating orbits to another of lower energy. When it does so, a photon is emitted having energy equal to the energy difference between the initial and final states.</p> <p>The radius of the n^{th} orbit is found as</p> $r_n = \left(\frac{n^2}{m}\right) \left(\frac{h}{2\pi}\right)^2 \frac{4\pi\epsilon_0}{e^2}$ <p>$r_n \propto n^2$</p> <p>Alternatively: Difference in radius of consecutive orbits is $r_{n+1} - r_n = k [(n+1)^2 - n^2]$ $= k (2n + 1)$ which depends on n, and is not a constant</p>	<p>1</p> <p>1</p> <p>1</p>	<p>3</p>						
28.	<table border="1" style="width: 100%; border-collapse: collapse;"> <tr> <td style="padding: 5px;">a) Stating two properties of a nucleus</td> <td style="text-align: right; padding: 5px;">1</td> </tr> <tr> <td style="padding: 5px;">b) Why density of a nucleus is much more than that of an atom</td> <td style="text-align: right; padding: 5px;">1</td> </tr> <tr> <td style="padding: 5px;">c) Showing that density of nuclear matter is same for all nuclei</td> <td style="text-align: right; padding: 5px;">1</td> </tr> </table> <p>a) (Any TWO)</p> <p>(i) The nucleus is positively charged</p> <p>(ii) The nucleus consists of protons and neutrons</p> <p>(iii) The nuclear density is independent of mass number</p> <p>(iv) The radius of the nucleus, $R = R_0 A^{1/3}$</p> <p>b) Atoms have large amount of empty spaces. Mass is concentrated in nucleus.</p>	a) Stating two properties of a nucleus	1	b) Why density of a nucleus is much more than that of an atom	1	c) Showing that density of nuclear matter is same for all nuclei	1	<p>$\frac{1}{2} + \frac{1}{2}$</p> <p>1</p>	
a) Stating two properties of a nucleus	1								
b) Why density of a nucleus is much more than that of an atom	1								
c) Showing that density of nuclear matter is same for all nuclei	1								

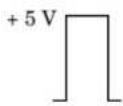
	<p>c) Density = Mass / Volume</p> $= \frac{m A}{\frac{4}{3}\pi R^3} = \frac{m A}{\frac{4}{3}\pi R_0^3 A}$ $= \frac{m}{\frac{4}{3}\pi R_0^3}$ <p>So, density is independent of mass number</p>	1	3
	<u>SECTION D</u>		
29.	<p>(i) (A) $\frac{2(n-1)}{R}$</p> <p>(ii) (D) P/2</p> <p>(iii) (B) P</p> <p>(iv) a) (C) 2P OR b) (A) 6.6 D</p>	1 1 1 1	4
30.	<p>(i) (A) $\frac{V_o}{\sqrt{2}}$</p> <p>(ii) (B) half cycle of the input signal</p> <p>(iii) (C) One is forward biased and the other is reverse biased at the same time</p> <p>(iv) a) (B) 50 Hz OR b) (D) </p>	1 1 1 1	4

Section E

31.

(a)

(i)

- Deriving the expression for potential energy 2
- Maximum & Minimum value of potential energy (1/2 + 1/2)

(ii) Finding the torque. 2

(i)

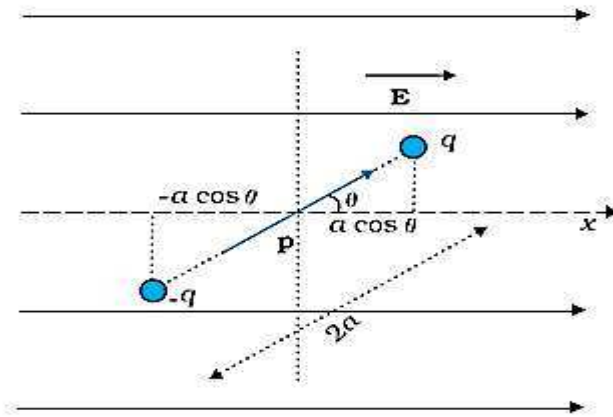

The amount of work done in rotating the dipole from $\theta = \theta_0$ to $\theta = \theta_1$ by the external torque

$$W = \int_{\theta_0}^{\theta_1} \tau_{ext} d\theta$$

$$= \int_{\theta_0}^{\theta_1} pE \sin \theta d\theta$$

$$W = pE(\cos \theta_0 - \cos \theta_1)$$

For $\theta_0 = \frac{\pi}{2}$ and $\theta_1 = \theta$

$$= pE(\cos \frac{\pi}{2} - \cos \theta)$$

$$U(\theta) = -pE \cos \theta$$

$$= -\vec{p} \cdot \vec{E}$$

1/2

1/2

1/2

1/2

(1) Potential energy is maximum when:

\vec{p} is antiparallel to \vec{E}

Alternatively:

$\theta = 180^\circ$ or π radians

1/2

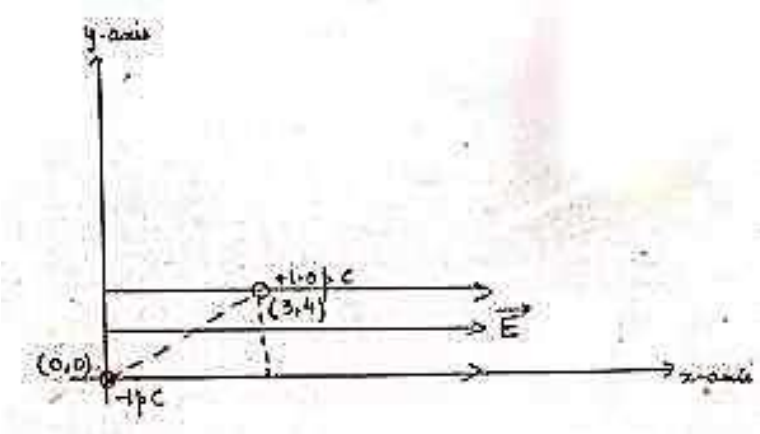
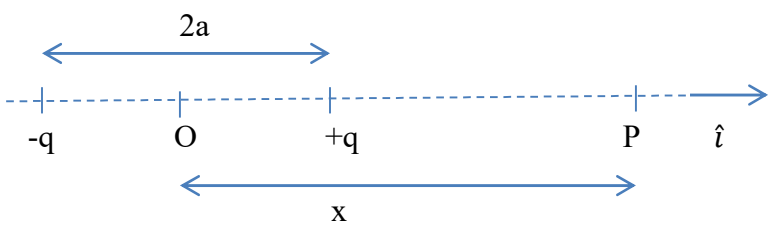
	<p>(2) Potential energy is minimum when: \vec{p} is along to \vec{E} Alternatively: $\theta = 0^\circ$</p> <p>(ii)</p>  <p> $\tau = pE \sin \theta$ $= (2aq)E \sin \theta$ $= (5 \times 10^{-3} \times 1 \times 10^{-12}) 10^3 \times \frac{4}{5}$ $= 4 \times 10^{-12} \text{ Nm}$ Direction is along -ve Z direction. </p>	<p>$\frac{1}{2}$</p> <p>$\frac{1}{2}$</p> <p>$\frac{1}{2}$</p> <p>$\frac{1}{2}$</p>					
	<p style="text-align: center;">OR</p> <p>(b)</p> <table border="1" style="margin-left: auto; margin-right: auto;"> <tr> <td>(i) Deriving expression for potential</td> <td>2 ½</td> </tr> <tr> <td>(ii) New charge on Sphere S_1</td> <td>2 ½</td> </tr> </table> <p>(i)</p>  <p> $V = \frac{1}{4\pi\epsilon_0} \frac{q}{r}$ $V = V_{+q} - V_{-q}$ </p>	(i) Deriving expression for potential	2 ½	(ii) New charge on Sphere S_1	2 ½	<p>$\frac{1}{2}$</p> <p>$\frac{1}{2}$</p>	
(i) Deriving expression for potential	2 ½						
(ii) New charge on Sphere S_1	2 ½						

$$V = \frac{1}{4\pi\epsilon_0} \left[\frac{q}{(x-a)} - \frac{q}{(x+a)} \right]$$

$$= \frac{q}{4\pi\epsilon_0} \left[\frac{x+a-x+a}{(x^2-a^2)} \right]$$

$$V = \frac{q}{4\pi\epsilon_0} \frac{2a}{(x^2-a^2)} = \frac{p}{4\pi\epsilon_0(x^2-a^2)}$$

As p is along x-axis, so

$$V = \frac{1}{4\pi\epsilon_0} \frac{\vec{p} \cdot \hat{i}}{(x^2-a^2)}$$

If $x \gg a$

$$V = \frac{1}{4\pi\epsilon_0} \frac{\vec{p} \cdot \hat{i}}{x^2}$$

Alternatively:

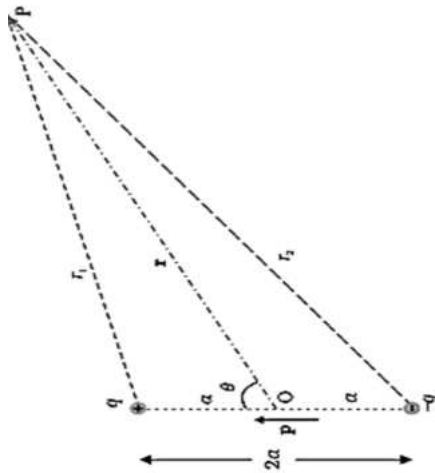

$$V = \frac{1}{4\pi\epsilon_0} \left(\frac{q}{r_1} - \frac{q}{r_2} \right)$$

----- (i)

1/2

1/2

1/2

1/2

By geometry

$$r_1^2 = r^2 + a^2 - 2ar \cos \theta$$

$$r_2^2 = r^2 + a^2 + 2ar \cos \theta$$

$$r_1^2 = r^2 \left(1 - \frac{2a \cos \theta}{r} + \frac{a^2}{r^2} \right)$$

$$\cong r^2 \left(1 - \frac{2a \cos \theta}{r} \right)$$

Similarly, $r_2^2 \cong r^2 \left(1 + \frac{2a \cos \theta}{r} \right)$

Using binomial theorem & retaining terms upto the first order in $\frac{a}{r}$; we obtain

$$\frac{1}{r_1} \cong \frac{1}{r} \left(1 - \frac{2a \cos \theta}{r} \right)^{-\frac{1}{2}} \cong \frac{1}{r} \left(1 + \frac{a}{r} \cos \theta \right) \quad \text{----- (ii)}$$

$$\frac{1}{r_2} \cong \frac{1}{r} \left(1 - \frac{2a \cos \theta}{r} \right)^{-\frac{1}{2}} \cong \frac{1}{r} \left(1 - \frac{a}{r} \cos \theta \right) \quad \text{----- (iii)}$$

Using equations (i) ,(ii) & (iii) & $p = 2qa$

$$V = \frac{q}{4\pi\epsilon_0} \frac{2a \cos \theta}{r^2} = \frac{p \cos \theta}{4\pi\epsilon_0 r^2}$$

$$p \cos \theta = \vec{p} \cdot \hat{r}$$

As \vec{r} is along the x - axis.

$$\Rightarrow \vec{p} \cdot \hat{r} = \vec{p} \cdot \hat{i}$$

$$\Rightarrow V = \frac{1}{4\pi\epsilon_0} \frac{\vec{p} \cdot \hat{i}}{x^2}$$

1/2

1/2

1/2

1/2

(ii)

Charge on sphere S_1 :

$$\begin{aligned} Q_1 &= \text{surface charge density} \times \text{surface Area} \\ &= \left(\frac{2}{\pi} \times 10^{-9} \right) \times 4\pi (1 \times 10^{-2})^2 \\ &= 8 \times 10^{-13} \text{ C} \end{aligned}$$

$\frac{1}{2}$

Charge on sphere S_2 :

$$\begin{aligned} Q_2 &= \text{surface charge density} \times \text{surface Area} \\ &= \left(\frac{2}{\pi} \times 10^{-9} \right) \times 4\pi (3 \times 10^{-2})^2 \\ &= 72 \times 10^{-13} \text{ C} \end{aligned}$$

$\frac{1}{2}$

When connected by a thin wire they acquire a common potential V and the charge remains conserved.

$$Q_1 + Q_2 = Q'_1 + Q'_2$$

$\frac{1}{2}$

$$= C_1 V + C_2 V$$

$$Q_1 + Q_2 = (C_1 + C_2) V$$

$$\text{Common potential}(V) = \frac{Q_1 + Q_2}{C_1 + C_2}$$

$$C_1 = 4\pi\epsilon_0 r_1 = \frac{1}{9 \times 10^9} \times 10^{-2} = \frac{1}{9} \times 10^{-11} \text{ F}$$

$$C_2 = 4\pi\epsilon_0 r_2 = \frac{1}{9 \times 10^9} \times 3 \times 10^{-2} = \frac{1}{3} \times 10^{-11} \text{ F}$$

$$V = \frac{80 \times 10^{-13}}{\left(\frac{1}{9} + \frac{1}{3} \right) \times 10^{-11}} = 1.8 \text{ V}$$

$\frac{1}{2}$

$$Q'_1 = C_1 V = \frac{1}{9} \times 10^{-11} \times 1.8$$

$$Q'_1 = 2 \times 10^{-12} \text{ C}$$

$\frac{1}{2}$

	<p>Alternatively:</p> <p>Charge on sphere S_1 :</p> $Q_1 = \text{surface charge density} \times \text{surface Area}$ $= \left(\frac{2}{\pi} \times 10^{-9}\right) \times 4\pi (1 \times 10^{-2})^2$ $= 8 \times 10^{-13} \text{ C}$ <p>Charge on sphere S_2 :</p> $Q_2 = \text{surface charge density} \times \text{surface Area}$ $= \left(\frac{2}{\pi} \times 10^{-9}\right) \times 4\pi (3 \times 10^{-2})^2$ $= 72 \times 10^{-13} \text{ C}$ <p>When connected by a thin wire they acquire a common potential V and the charge remains conserved.</p> $Q_1 + Q_2 = Q'_1 + Q'_2$ $\frac{Q'_2}{Q'_1} = \frac{r_2}{r_1}$ <p>On solving, $Q'_1 = 2 \times 10^{-12} \text{ C}$</p>	<p>$\frac{1}{2}$</p> <p>$\frac{1}{2}$</p> <p>$\frac{1}{2}$</p> <p>$\frac{1}{2}$</p> <p>$\frac{1}{2}$</p>	<p>5</p>						
<p>32.</p>	<p>(a)</p> <table border="1" data-bbox="324 1444 1096 1581"> <tr> <td>(i) Deriving expression for impedance</td> <td>2</td> </tr> <tr> <td>(ii) Reason</td> <td>1</td> </tr> <tr> <td>(iii) Inductance of coil</td> <td>2</td> </tr> </table>	(i) Deriving expression for impedance	2	(ii) Reason	1	(iii) Inductance of coil	2		
(i) Deriving expression for impedance	2								
(ii) Reason	1								
(iii) Inductance of coil	2								

	<p>(iii) $R = \frac{110}{11} = 10 \Omega$</p> $i_{rms} = \frac{v_{rms}}{\sqrt{R^2 + X_L^2}} = \frac{220}{\sqrt{100 + X_L^2}}$ $11 = \frac{220}{\sqrt{100 + X_L^2}}$ $\sqrt{100 + X_L^2} = \frac{220}{11} = 20\Omega$ <p>Squaring both sides:</p> $\Rightarrow 100 + X_L^2 = 400$ $\Rightarrow X_L^2 = 300 \Rightarrow X_L = 10\sqrt{3} \Omega$ $X_L = 2\pi fL \Rightarrow 10\sqrt{3} = 2\pi \times 50 \times L$ $L = \frac{\sqrt{3}}{10\pi} H$ <p style="text-align: center;">OR</p>	<p style="text-align: center;">$\frac{1}{2}$</p> <p style="text-align: center;">$\frac{1}{2}$</p> <p style="text-align: center;">$\frac{1}{2}$</p> <p style="text-align: center;">$\frac{1}{2}$</p>													
	<p>(b)</p> <table border="1" style="width: 100%; border-collapse: collapse;"> <tbody> <tr> <td>(i) Labelled diagram of step – up transformer</td> <td style="text-align: right;">1</td> </tr> <tr> <td> Describing working principle</td> <td style="text-align: right;">$\frac{1}{2}$</td> </tr> <tr> <td> Three causes</td> <td style="text-align: right;">$1 \frac{1}{2}$</td> </tr> <tr> <td>(ii) Explanation</td> <td style="text-align: right;">1</td> </tr> <tr> <td>(iii) (1) Output voltage across secondary coil</td> <td style="text-align: right;">$\frac{1}{2}$</td> </tr> <tr> <td> (2) Current in primary coil</td> <td style="text-align: right;">$\frac{1}{2}$</td> </tr> </tbody> </table>	(i) Labelled diagram of step – up transformer	1	Describing working principle	$\frac{1}{2}$	Three causes	$1 \frac{1}{2}$	(ii) Explanation	1	(iii) (1) Output voltage across secondary coil	$\frac{1}{2}$	(2) Current in primary coil	$\frac{1}{2}$		
(i) Labelled diagram of step – up transformer	1														
Describing working principle	$\frac{1}{2}$														
Three causes	$1 \frac{1}{2}$														
(ii) Explanation	1														
(iii) (1) Output voltage across secondary coil	$\frac{1}{2}$														
(2) Current in primary coil	$\frac{1}{2}$														

(i)

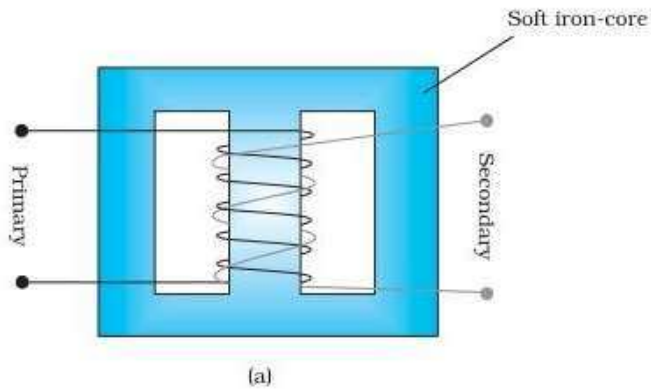

OR

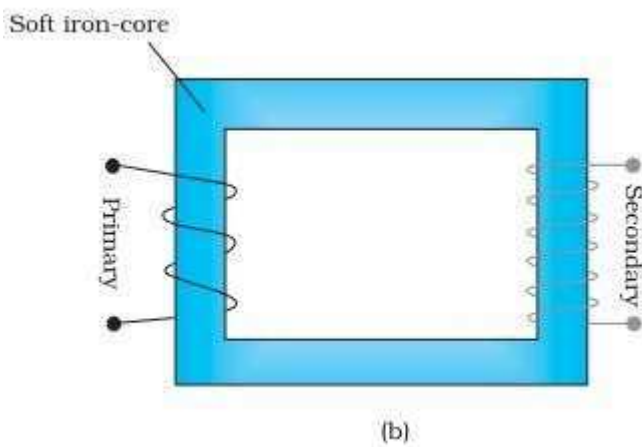

The working principle of transformer is mutual induction.

When an alternating voltage is applied to the primary, the resulting current produces an alternating magnetic flux which links the secondary and induces an emf in it.

Causes of energy losses (Any three)

- (a) Flux leakage
- (b) Resistance of the windings
- (c) Eddy currents

1

1/2

	<p>(d) Hysteresis</p> <p>(ii) No</p> <p>Current changes correspondingly. So, the input power is equal to the output power.</p> <p>(iii)</p> <p>(1)</p> $\frac{V_s}{V_p} = \frac{N_s}{N_p}$ $V_s = \frac{N_s}{N_p} \times V_p = \frac{3000}{200} \times 90$ $V_s = 1350 V$ <p>(2)</p> $\frac{I_p}{I_s} = \frac{N_s}{N_p}$ $I_p = \frac{3000}{200} \times 2 = 30 A$	<p>$\frac{1}{2} + \frac{1}{2} + \frac{1}{2}$</p> <p>$\frac{1}{2}$</p> <p>$\frac{1}{2}$</p> <p>$\frac{1}{2}$</p> <p>$\frac{1}{2}$</p>											
33.	<p>(a)</p> <table border="1" data-bbox="250 1404 1208 1824"> <tr> <td>(i) Graph showing variation of angle of deviation with angle of incidence</td> <td>1</td> </tr> <tr> <td>Defining angle of minimum deviation</td> <td>1</td> </tr> <tr> <td>(ii) Proof of refractive index $n = \frac{\sin(A + \delta)}{\sin A}$</td> <td>1</td> </tr> <tr> <td>(iii) (1) Finding angle of minimum deviation</td> <td>1</td> </tr> <tr> <td>(2) Angle of Incidence</td> <td>1</td> </tr> </table>	(i) Graph showing variation of angle of deviation with angle of incidence	1	Defining angle of minimum deviation	1	(ii) Proof of refractive index $n = \frac{\sin(A + \delta)}{\sin A}$	1	(iii) (1) Finding angle of minimum deviation	1	(2) Angle of Incidence	1		5
(i) Graph showing variation of angle of deviation with angle of incidence	1												
Defining angle of minimum deviation	1												
(ii) Proof of refractive index $n = \frac{\sin(A + \delta)}{\sin A}$	1												
(iii) (1) Finding angle of minimum deviation	1												
(2) Angle of Incidence	1												

(i)

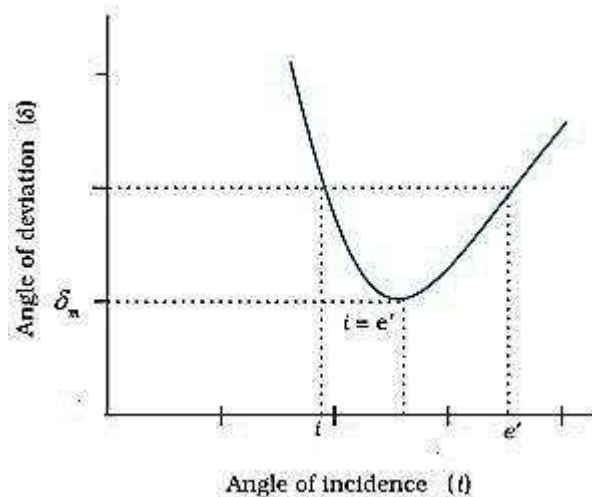

1

Minimum deviation angle is defined as the angle at which angle of incidence is equal to the angle of emergence.

1

Alternatively

At minimum deviation refracted ray inside the prism becomes parallel to the base of the prism.

(ii)

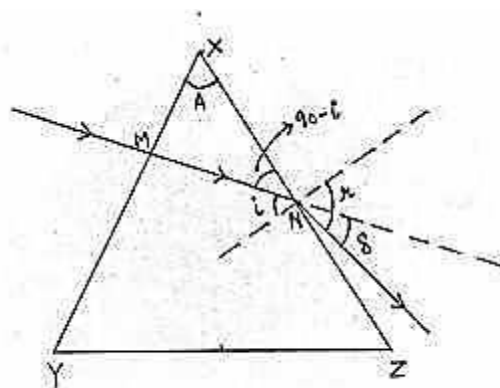

At the face XZ :-

$$\mu \sin i = 1 \times \sin r \quad \text{----- (1)}$$

$$r = i + \delta \quad \text{[from diagram]} \quad \text{----- (2)}$$

$$\text{In } \triangle XMN; \quad A + (90 - i) + 90 = 180$$

$\frac{1}{2}$

	$\Rightarrow A = i \quad \text{----- (3)}$ <p>Putting eq. (3) & (2) in eq. (1)</p> $\mu \sin A = \sin(A + \delta)$ $\mu = \frac{\sin(A + \delta)}{\sin A}$ <p>(iii)</p> $(1) \quad \mu = \frac{\sin\left(\frac{A + \delta_m}{2}\right)}{\sin\frac{A}{2}}$ $\sqrt{2} = \frac{\sin\left(\frac{60 + \delta_m}{2}\right)}{\sin 30^\circ}$ $\Rightarrow \sin\left(\frac{60 + \delta_m}{2}\right) = \frac{1}{\sqrt{2}} = \sin 45^\circ$ $\frac{60 + \delta_m}{2} = 45^\circ \Rightarrow \delta_m = 30^\circ$ $(2) \quad i = \frac{A + \delta_m}{2}$ $\Rightarrow i = \frac{60 + 30}{2}$ $i = 45^\circ$ <p style="text-align: center;">OR</p>	<p>$\frac{1}{2}$</p> <p>$\frac{1}{2}$</p> <p>$\frac{1}{2}$</p> <p>$\frac{1}{2}$</p> <p>$\frac{1}{2}$</p>													
	<p>(b)</p> <table border="1" style="width: 100%; border-collapse: collapse;"> <tbody> <tr> <td>(i) Statement of Huygens' Principle</td> <td style="text-align: right;">$\frac{1}{2}$</td> </tr> <tr> <td>Construction of reflected wave front</td> <td style="text-align: right;">$\frac{1}{2}$</td> </tr> <tr> <td>Proof of angle of reflection is equal to angle of incidence</td> <td style="text-align: right;">1</td> </tr> <tr> <td>(ii) Definition of coherent sources</td> <td style="text-align: right;">$\frac{1}{2}$</td> </tr> <tr> <td>Explanation</td> <td style="text-align: right;">1</td> </tr> <tr> <td>(iii) Finding the unknown wavelength</td> <td style="text-align: right;">$1 \frac{1}{2}$</td> </tr> </tbody> </table> <p>(i) Each point of the wavefront is the source of a secondary disturbance and the wavelets emanating from these points spread out in all directions with the spread of the wave. Each point of the wavefront is the source of a</p>	(i) Statement of Huygens' Principle	$\frac{1}{2}$	Construction of reflected wave front	$\frac{1}{2}$	Proof of angle of reflection is equal to angle of incidence	1	(ii) Definition of coherent sources	$\frac{1}{2}$	Explanation	1	(iii) Finding the unknown wavelength	$1 \frac{1}{2}$		
(i) Statement of Huygens' Principle	$\frac{1}{2}$														
Construction of reflected wave front	$\frac{1}{2}$														
Proof of angle of reflection is equal to angle of incidence	1														
(ii) Definition of coherent sources	$\frac{1}{2}$														
Explanation	1														
(iii) Finding the unknown wavelength	$1 \frac{1}{2}$														

secondary disturbance and the wavelets emanating from these points spread out in all directions with the speed of the wave. These wavelets emanating from the wavefront are usually referred to as secondary wavelets and if we draw a common tangent to all these spheres, we obtain the new position of the wavefront at a later time.

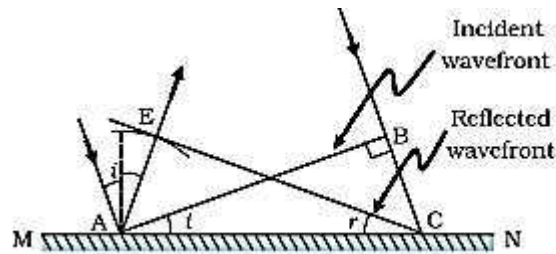

$\triangle EAC$ is congruent to $\triangle BAC$; so $\angle i = \angle r$

(ii) Two sources are said to be coherent if the phase difference between them does not change with time.

No, two independent sodium lamps cannot be coherent.

Two independent sodium lamps cannot be coherent as the phase between them does not remain constant with time.

(iii)

$$4\beta_2 = 5\beta_1$$

$$4 \times \frac{\lambda D}{d} = 5 \times \frac{\lambda_{known} D}{d}$$

$$\Rightarrow \lambda = \frac{5}{4} \times \lambda_{known}$$

$$= \frac{5}{4} \times 520$$

$$= 650 \text{ nm}$$

$\frac{1}{2}$

$\frac{1}{2}$

1

$\frac{1}{2}$

$\frac{1}{2}$

$\frac{1}{2}$

$\frac{1}{2}$

1

5