

MARKING SCHEME CODE: B

SECTION A

1. (d) stat coulomb 1
2. (b) -60 cm 1
3. (a) 6000 A° 1
4. (b) a vacancy created when an electron leaves a covalent bond. 1
5. (d) Holes are majority carriers and trivalent atoms are the dopants. 1
6. (c) 18 pm. 1
7. (c) Both the frequency of incident light and the material of the cathode. 1
8. (c) Giga hertz. 1
9. (b) helical 1
10. (b) repel each other 1
11. (d) 120 V 1
12. (a) 4 R 1
13. (b) energy 1
14. (c) less reactance 1
15. (d) A is false but R is also false. 1
16. (c) A is true but R is false. 1
17. (d) A is false but R is also false. 1
18. (c) A is true but R is false. 1

SECTION B

19. **Electromagnetic waves** are the waves in which electric field and magnetic field vectors are perpendicular to each other as well as perpendicular to direction of propagation. 1

Two uses of gamma rays—

1. γ -rays are used in the treatment of cancer and tumours. ½
2. These are used to produce nuclear reactions. ½

OR

$$B_0 = 510 \text{ nT} = 510 \times 10^{-9} \text{ T}$$

$$E_0 = CB_0 \quad 1$$

$$= 3 \times 10^8 \times 510 \times 10^{-9} \quad \frac{1}{2}$$

$$= 153 \text{ NC}^{-1} \quad \frac{1}{2}$$

20. Binding energy of a nucleus is the energy with which nucleons are bound in the nucleus. 1

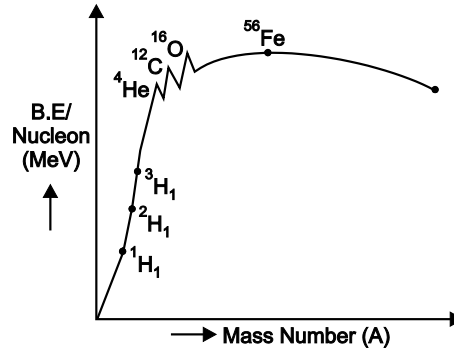

21. $I = neAv_d$ 1/2

$$= neA \left(\frac{eE\tau}{m} \right) = \frac{ne^2AE\tau}{m}$$

$$\frac{I}{A} = \frac{ne^2E\tau}{m} \quad \dots(1) \quad \frac{1}{2}$$

Take $I = \frac{I}{A}$ and $\sigma = \frac{ne^2\tau}{m}$ 1/2

Put in (1)

$$\therefore \mathbf{J = \sigma E.} \quad \frac{1}{2}$$

22. Total charge present on a body is fixed. Total charge is integral multiple of smallest unit of charge *i.e.* electronic charge. 1

$$Q = ne$$

At macroscopic level total charge present on a body is much larger than the charge on an electron.

Granary nature of charge on electron vanishes. So it has no practical consequence at macroscopic level. 1

23. Let us consider PQRS a rectangular coil placed in mag. field which is \perp to plane of paper and acting inward.

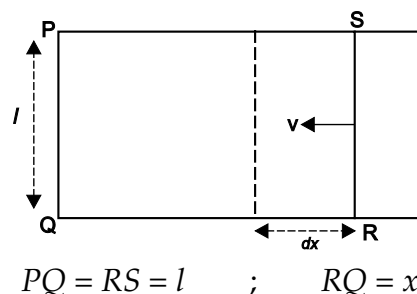

Let RS is moved towards left with constant velocity v . The area enclosed by $PQRS$ decreases. Amount of mag. flux linked with loop decreases. 1

$$\phi = Blx$$

$$e = \frac{-d\phi}{dt} = \frac{-d}{dt}(Blx) = Bl\left(\frac{-dx}{dt}\right)$$

$$= Blv$$

$$e = Blv.$$

1

24. A water tank appears shallower due to refraction of light.

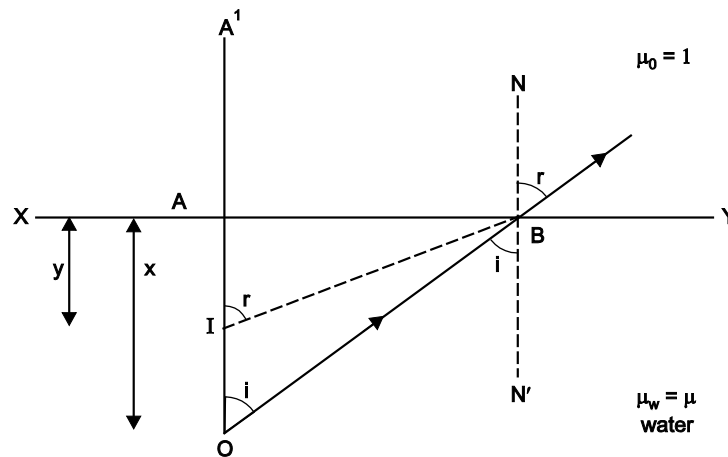

$$OA = x = \text{Real depth}$$

$$AI = y = \text{App. depth}$$

1/2

Apply Snell's law

$$\frac{\sin i}{\sin r} = {}^w\mu_a = \frac{1}{\mu}$$

1/2

$$\mu = \frac{\sin r}{\sin i} = \frac{AB}{IB} \times \frac{OB}{AB}$$

$$\mu = \frac{OB}{IB}$$

If pt. B is near to pt. A then $OA \approx OB = x$ and $IB = IA = y$.

$$\mu = \frac{OB}{IB} \approx \frac{OA}{IA} = \frac{x}{y} = \frac{\text{Real depth}}{\text{App. depth}}$$

$$A \cdot D = \frac{R \cdot D}{\mu}.$$

1

25. (a) The geometrical shape of the wave front would be diverging spherical wave front as shown in fig.

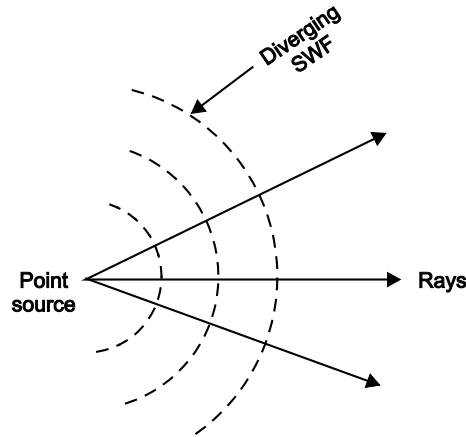

1

(b) As the star (i.e., source of light) is very far off i.e. at infinity, the wave front intercepted by earth must be a plane wave front as shown in fig.

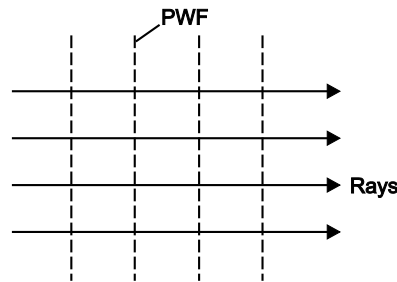

1

OR

Interference	Diffraction
1. It is the redistribution of light energy waves coming from two coherent sources.	1. It is the bending of light around corners of an obstacle.
2. All the bright fringes are of same intensity in interference pattern.	2. All the bright bands are not of the same intensity in diffraction pattern.

1 + 1

SECTION C

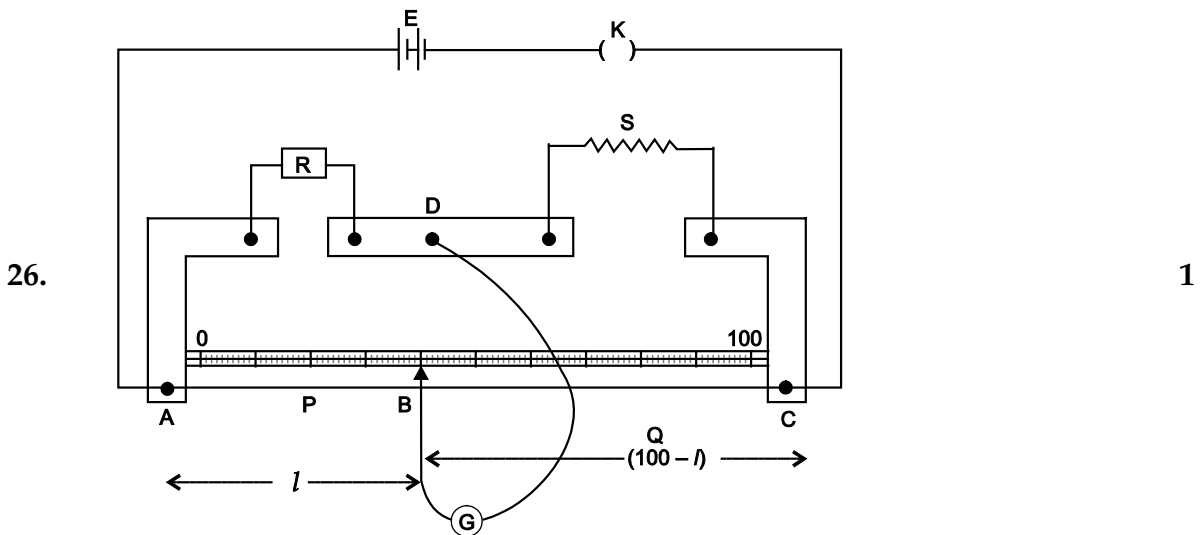

Arrange the circuit as shown in figure

Close the key K and take out suitable resistance R from resistance box. Slide the jockey to find balancing length.

Let $AB = l =$ balancing length

$$BC = (100 - l) \quad 1$$

Acc to Wheat stone bridge principle

$$\frac{P}{Q} = \frac{R}{S}$$

If r is resistance per unit length of wire

when
$$\frac{lr}{(100-l)r} = \frac{R}{S}$$

or
$$S = \left(\frac{100-l}{l} \right) R \quad 1$$

27. Line integral of the magnetic field over a closed path is equal to μ_0 times the net current (I) passing through the enclosed path.

$$\oint \vec{B} \cdot d\vec{l} = \mu_0 I \quad 1$$

Proof: Consider a long thin straight conductor XY , carrying current as shown in fig.

Mag. field as P at a distance r is given by

$$B = \frac{\mu_0}{4\pi} \frac{2I}{r} \quad 1$$

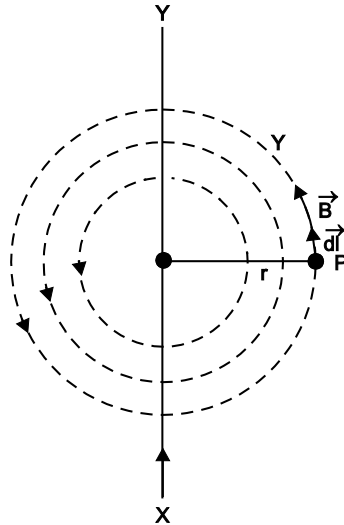

dirⁿ of \vec{B} is along the tangent to mag. field line at that point.

$$\begin{aligned} \oint \vec{B} \cdot d\vec{l} &= \oint B dl \cos 0 = B \oint dl \\ &= \frac{\mu_0}{4\pi} \frac{2I}{r} (2\pi r) = \mu_0 I \end{aligned} \quad \mathbf{1}$$

OR

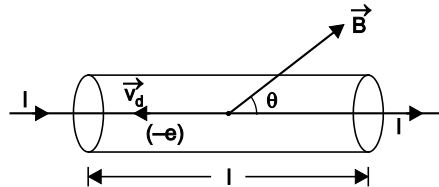

Let a conductor of length l and area of cross-section A carrying current I is placed in mag. field \vec{B} . $\mathbf{1}$

force on electron in mag. field $\vec{f}_1 = -e (\vec{v}_d \times \vec{B})$...(1)

vol. of conductor = Al

If n be the no. of e 's per unit volume.

Total force on conductor:

$$\begin{aligned} \vec{F} = N \vec{f}_1 &= nAl \left[-e (\vec{v}_d \times \vec{B}) \right] \\ &= -nAle (\vec{v}_d \times \vec{B}) \end{aligned} \quad \mathbf{...(2) \quad 1}$$

we know

$$I = ne A v_d$$

$$I \vec{l} = -nAle \vec{v}_d \quad \mathbf{...(3)}$$

-ve sign shows that current is opposite to drift velocity of electron.

$$\vec{F} = -nAle (\vec{v}_d \times \vec{B})$$

$I \vec{l}$ = current element.

$$\vec{F} = I(\vec{l} \times \vec{B}). \quad 1$$

28.	Step-up transformer	Step-down transformer
	1. It converts low input voltage into high output voltage.	1. It converts high input voltage into low output voltage.
	2. The no. of turns in its secondary coil is more than in its primary. $n_s > n_p$	2. The no. of turns in its secondary coil is less than in its primary. $n_s < n_p$

1 + 1

Two reasons of energy Loss—

1. Copper loss is the energy loss in the form of heat in the copper coils of transformer.
2. Iron loss is in the form of heat in the iron core of transformer. ½ + ½

OR

$$L = 5.0H, \quad C = 80 \times 10^{-6}F, \quad R = 40\Omega$$

(a) $X_L = X_C$ 1

$$\omega L = \frac{1}{\omega C}$$

$$\omega = \frac{1}{\sqrt{LC}} = \frac{1}{\sqrt{5 \times 80 \times 10^{-6}}} = 50 \text{ rad/s} \quad 1$$

(b) At resonance, $Z = R = 40 \Omega$ 1

$$I_0 = \frac{V_0}{Z} = \frac{\sqrt{2}V}{Z} = \frac{\sqrt{2} \times 230}{40} = 8.13A \quad 1$$

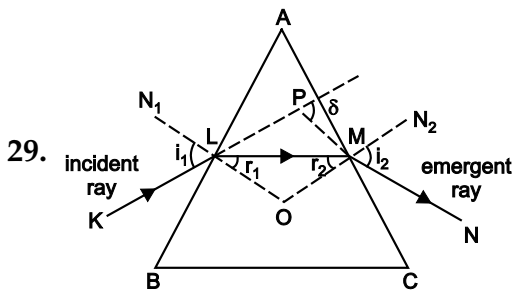

Let i_1 = angle of incidence
 i_2 = angle of emergence (e)
 r_1, r_2 = angle of refraction
 A = angle of prism

In $\triangle PLM$ $\delta = \angle PLM + \angle PML$
 $= (i_1 - r_1) + (i_2 - r_2)$
 $= (i_1 - i_2) + (r_1 - r_2)$... (1)

In $\triangle OLM$ $\angle O + r_1 + r_2 = 180^\circ$
 In quad. $ALOM$ $\angle A + \angle O = 180^\circ$
 $\therefore \angle O + r_1 + r_2 = \angle A + \angle O$
 $\therefore A = r_1 + r_2$ 1

Put in (1)
 $\delta = (i_1 + i_2) - A$... (2)
 $\mu = \frac{\sin i}{\sin r} \approx \Rightarrow i_1 = \mu r_1$ Similarly, $i_2 = \mu r_2$

Put in (2)
 $\delta = (\mu r_1 + \mu r_2) - A$
 $= \mu(r_1 + r_2) - A$
 $= \mu A - A$
 $\delta = (\mu - 1)A$... (3) 1

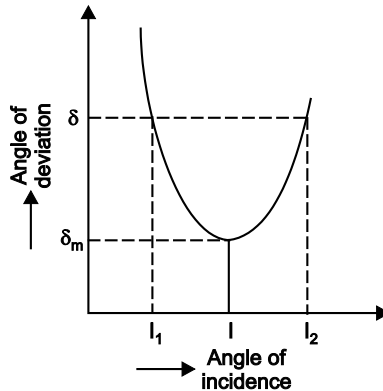

At minimum deviation $\delta = \delta_m$
 $i_1 = i_2$ and $i = e$ (say)
 $r_1 = r_2 = r$ (say)
 $A = r_1 + r_2$ from eqn. (2)
 $= r + r = 2r$ $\delta_m = i + i - A$
 $r = A/2$ $= 2i - A$
 $\Rightarrow i = \left(\frac{A + \delta_m}{2} \right)$

As
$$\mu = \frac{\sin i}{\sin r} = \frac{\sin\left(\frac{A + \delta_m}{2}\right)}{\sin\left(\frac{A}{2}\right)} \quad 1$$

which is prism formula.

30. Einstein's Photoelectric Equation

$$K_{\max} = \frac{1}{2} m v_{\max}^2 = h\nu - \phi_0 \quad 1$$

where

ϕ_0 = work function of the metal

K_{\max} = maximum kinetic energy

Relation between cut-off potential, frequency of incident photon and threshold frequency.

$$K_{\max} = h\nu - \phi_0 \quad \dots(1)$$

If V_0 is cutoff potential and e is charge on electron

$$\therefore K_{\max} = e V_0$$

and

$$\phi_0 = h \nu_0 \quad 1$$

Put in (1)

$$K_{\max} = h\nu - h\nu_0 = h(\nu - \nu_0)$$

$$eV_0 = K_{\max} = \left(\frac{c}{\lambda} - \frac{c}{\lambda_0} \right)$$

$$eV_0 = K_{\max} = h c \left(\frac{1}{\lambda} - \frac{1}{\lambda_0} \right). \quad 1$$

SECTION D

31. (a)

$$S_x = v_x \times t$$

$$3 \times 10^{-2} = 3 \times 10^7 \times t$$

$$\therefore t = 10^{-9} \text{ s} \quad 1$$

(b) Parabolic path due to accelerated motion in a fixed direction \perp to initial velocity. 1/2 + 1/2

$$(c) \quad a_y = \frac{eE}{m} = \frac{e}{m} \left(\frac{V}{l} \right)$$

$$V = a_y \frac{ml}{e}$$

$$y = U_y t + \frac{1}{2} a_y t^2$$

$$y = \frac{1}{2} \text{ cm} = 0.5 \times 10^{-2} \text{ m}$$

$$= \frac{10^6 \times 9.1 \times 10^{-31} \times 10^{-2}}{1.6 \times 10^{-19}} \left| \begin{array}{l} \therefore 0.5 \times 10^{-2} = 0 + \frac{1}{2} a_y (10^{-9})^2 \\ \therefore a_y = 10^6 \text{ m/s}^2 \end{array} \right. \quad 2$$

OR

$$qE = qvB$$

$$B = \frac{E}{v} = \frac{1}{v} \left(\frac{m a_y}{e} \right)$$

$$= \frac{1}{3 \times 10^7} \left(\frac{9.1 \times 10^{-31} \times 10^{16}}{1.6 \times 10^{-19}} \right)$$

$$= 1.9 \times 10^{-3} \text{ T}$$

Direction of mag. field will be out of plane of paper. 2

32. 1. Nuclear force is the force which exists between the protons and neutrons present in a nucleus to keep them together. 1
2. (d) strong nuclear force. 1
3. (c) nuclear forces. 1
4. $R = R_0 A^{1/3}$ 1
 where R_0 is empirical constant.

OR

$$A_1 : A_2 = 1 : 3$$

$$\rho_1 : \rho_2 = 1 : 1$$

1

SECTION E

33. Forward Characteristics of p-n junction diode

These are the graphical relations between forward bias voltage and forward current.

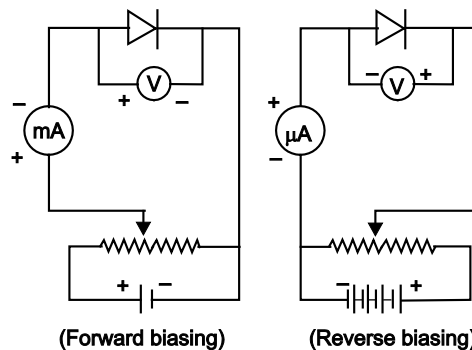

1 + 1

At some forward voltage *i.e.*, 0.7 V for Si and 0.3 V for Ge known as knee voltage the potential barrier is almost eliminated and the current starts flowing and curve rises sharply as shown in Fig.

Reverse Characteristic : These are the graphical relations between reverse voltage and reverse current.

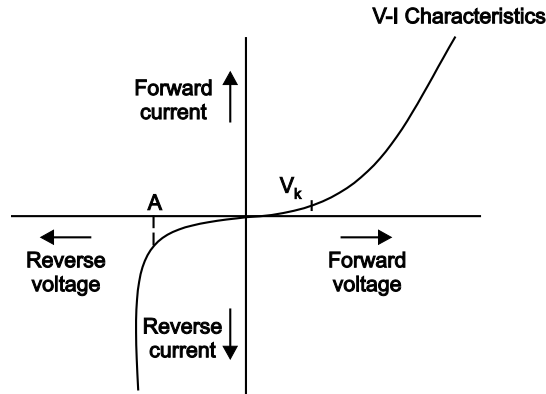

1 + 1

Breakdown voltage : It is the reverse voltage at which the breakdown of junction takes place and reverse current increases rapidly. It is shown by the region OA. If reverse current increases the safest rated value of diode then it will get damaged. 1

OR

Two processes are:

(a) **Diffusion**—Due to concentration, difference electrons move from $n \rightarrow p$ side and holes from $p \rightarrow n$ side. This movement of majority charge carrier is called diffusion. 1

(b) **Drift**—The motion of charge carrier due to electric field *i.e.* an electron on p -side moves to n -side and hole on n -side moves to p -side of junction is called drift. 1

Half-wave Rectifier

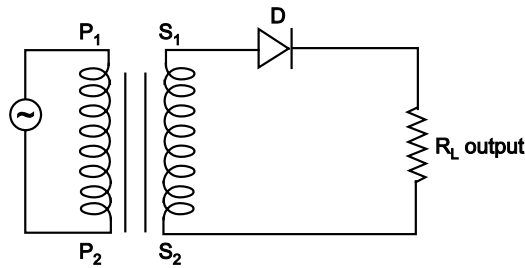

1

During the half cycle diode D is forward biased and forward current flows through the diode; we get output. During $-ve$ half cycle diode D will be reverse biased hence will not conduct. The output waveform is shown in fig. 1

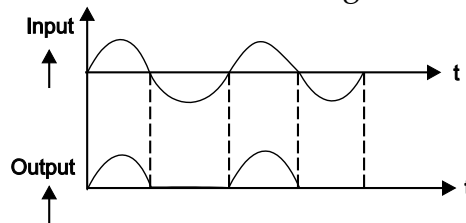

1

34. It consists of two convex lens of an objective lens of very small focal length and small aperture but eye piece of moderate focal length and large aperture.

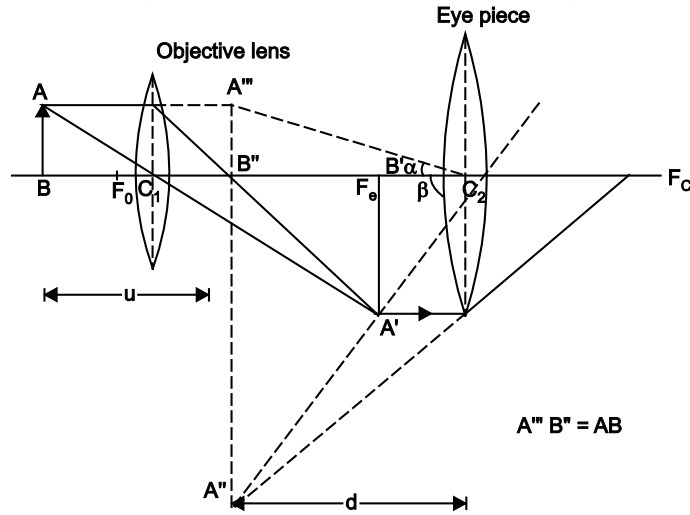

1

Magnifying power of compound microscope is defined as ratio of angle subtended by final image and object on eye when both are at least distance of distinct vision.

1

$$m = \frac{\beta}{\alpha} = \frac{\tan \beta}{\tan \alpha} \quad \dots(1) \quad \text{In } \triangle A''B''C_2 \tan \beta = \frac{A''B''}{C_2B''}$$

$$m = \frac{A''B''}{AB} \quad \text{In } \triangle A'B'C_1 \tan \alpha = \frac{A'B'}{C_1B'}$$

$$= \frac{A''B''}{A'B'} \times \frac{A'B'}{AB} = \frac{AB}{C_2B''}$$

$$m = m_e m_o \quad \dots(2)$$

1

Where $m_o = \frac{A'B'}{AB} = \text{magnification of objective lens}$

$$m_e = \frac{A''B''}{A'B'} = \text{magnification produced by eye lens.}$$

$$= \left(1 + \frac{d}{f_e}\right)$$

In $\triangle ABC_1$ and $\triangle A'B'C_1$

$$\frac{A'B'}{AB} = \frac{C_1B'}{C_1B} = \frac{v_o}{-u}$$

1

Put in (2)

$$m = \frac{v_o}{-u_0} \left(1 + \frac{d}{f_e}\right) = \frac{v_o}{|u_0|} \left(1 + \frac{d}{f_e}\right)$$

$$m = \frac{L}{(f_0)} \left(1 + \frac{d}{f_e} \right) \quad \because \text{object is close to } F_0. \quad 1$$

$$m = \frac{L}{-f_0} \left(1 + \frac{d}{f_e} \right)$$

-ve sign shows that final image is inverted.

OR

It is the phenomenon of reflection of light into a denser medium from an interface of this denser medium and a rarer medium. 1

Two essential conditions of TIR—

1. Light should travel from denser to rarer medium.
2. Angle of incidence in denser medium should be greater than critical angle for the pair of media in contact. 2

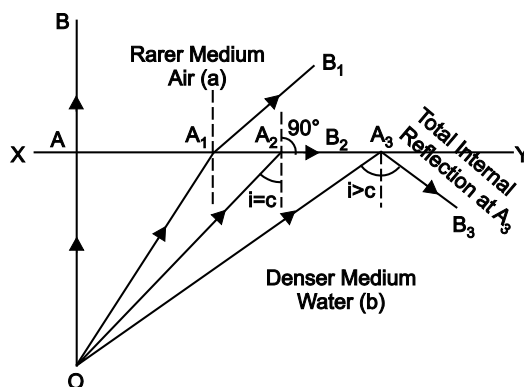

Optical fibres are the threads of glass or quartz of ref. index 1.5 coated with a thin layer of material having low ref. index nearly 1.48.

When light falls at one end of the optical fibre. The refracted ray falls with angle greater than critical angle TIR takes place and finally ray come out of other end without any loss.

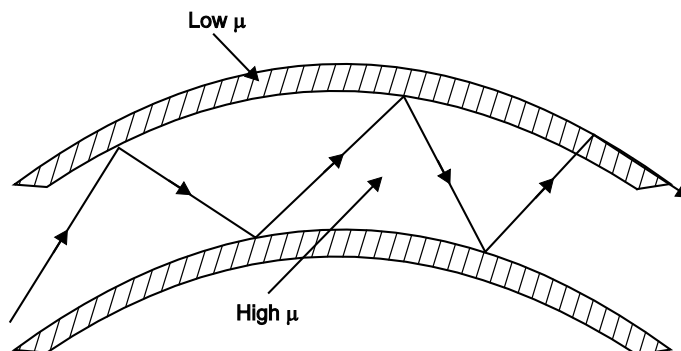

2

35. At a point outside the shell

Consider a +ve charge q distributed uniformly on the surface of spherical shell of radius R .

Let P is a pt. outside the shell at a distance $r > R$.

Draw a gaussian sphere of radius r with centre O .

1

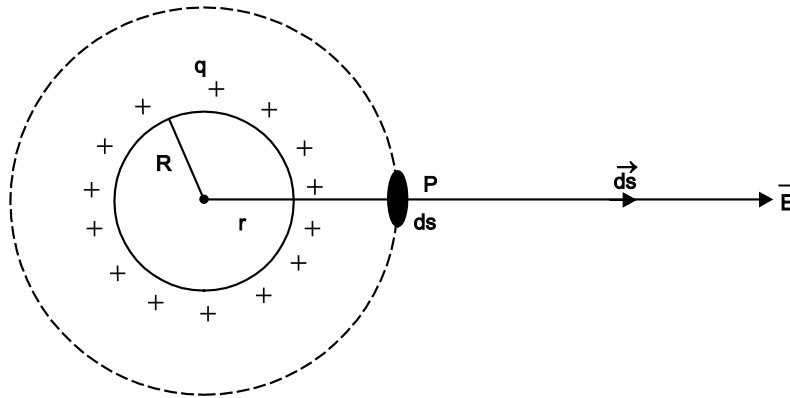

Acc. to Gauss's Th^m

$$\oint \vec{E} \cdot \vec{ds} = \frac{q}{\epsilon_0}$$

$$\oint E ds \cos 0 = \frac{q}{\epsilon_0}$$

$$E \oint ds = \frac{q}{\epsilon_0}$$

$$E(4\pi r^2) = \frac{q}{\epsilon_0} \Rightarrow E = \frac{q}{4\pi\epsilon_0 r^2}$$

Take

$$q = \sigma 4\pi R^2$$

Where

σ = surface charge density

$$E = \frac{\sigma 4\pi R^2}{4\pi\epsilon_0 r^2}$$

$$E = \frac{\sigma R^2}{\epsilon_0 r^2}$$

$$E \propto \frac{1}{r^2} \quad \text{for } r > R$$

2

At a pt. inside the shell

$$\oint \vec{E} \cdot \vec{ds} = \frac{q}{\epsilon_0} \quad \because \quad q = 0 \text{ inside the gaussian surface}$$

$$E = 0$$

1

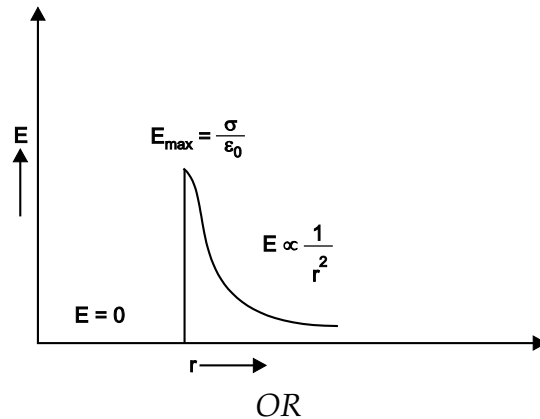

A capacitor is an electronic device that stores electrical energy by accumulating electric charge on two closely spaced surface that are insulated from each other. 1

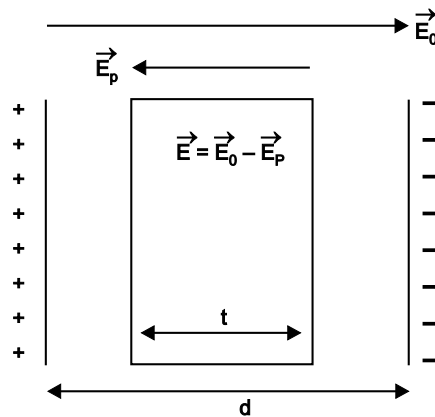

1

Let $C_0 = \frac{A\epsilon_0}{d}$ be capacitance of capacitor with air between the plates.

Let $t =$ thickness of dielectric slab introduced between the plates. $t < d$.

$\vec{E}_p =$ electric field due to the surface charges. Net electric field $\vec{E} = \vec{E}_0 - \vec{E}_p$

$V =$ Potential difference b/w the plates

$$= E_0(d - t) + E(t)$$

1

$$= E_0(d - t) + \frac{E_0 t}{k}$$

$$= E_0 \left[d - t + \frac{t}{k} \right]$$

$$V = \frac{Q}{A\epsilon_0} \left[d - t + \frac{t}{k} \right]$$

As

$$C = \frac{Q}{V} = \frac{Q}{\frac{Q}{A\epsilon_0} \left(d - t + \frac{t}{k} \right)}$$

$$C = \frac{A\epsilon_0}{d\left(1 - \frac{t}{d} + \frac{t}{kd}\right)}$$

$$C = \frac{C_0}{\left(1 - \frac{t}{d} + \frac{t}{kd}\right)}$$

i.e., $C > C_0$ *i.e.* capacitance increases on introducing dielectric slab.

2

If $t = d$ $C = C_0K$.